



**PETROL EARTH AUGER**  
**RACTT50-4**  
**USER GUIDE**

**CAUTION:** Read this manual before using this machine!

# CONTENTS

1. INTENDED USE.....	3
2. SAFETY INSTRUCTIONS.....	3
3. YOUR PRODUCT.....	7
4. FILLING THE FUEL TANK.....	9
5. ASSEMBLY AND OPERATION.....	9
6. MAINTENANCE.....	13
7. TROUBLESHOOTING.....	15
8. STORAGE AND TRANSPORTATION.....	16
9. DECLARATION OF CONFORMITY.....	17
10. WARRANTY.....	18
11. PRODUCT FAILURE.....	19
12. WARRANTY EXCLUSIONS.....	20

# 1. INTENDED USE

This electric auger is designed to work for the ground (drilling holes for planting small trees, fence posts and similar objects). It is designed to be used with both hands.

This machine is not designed to operate on frozen soil, on very rocky and particularly hard soil, in areas with underground electrical, gas or telephone lines.

This machine should only be used in an upright position.

# 2. SAFETY INSTRUCTIONS

**THIS MACHINE MAY CAUSE SERIOUS INJURIES. Read the instructions carefully for handling, preparing, maintaining, starting and stopping the machine. Learn more about all the controls and proper use of the machine.**

- **WARNING!** When using this type of tool, basic precautions should always be followed to reduce the risk of fire, electric shock and injury.
- Read all instructions carefully before attempting to use this product and retain these instructions. Be familiar with all the operations described in these operating instructions. This product must be operated and operated by experienced users.
- If you are giving this machine to others, please also provide them with this instructions manual.
- Also read all markings on the product. The symbols on the tools are explained in the manual.
- Use this machine as described in this instruction manual. It is strictly forbidden to use this tool for applications other than those described in this manual.
- Failure to follow these instructions can result serious injuries and, in some cases, death.
- This product is intended for private domestic use only.
- Do not use it for commercial purposes.
- Never let people unfamiliar with these instructions or children use this product.
- National regulations may limit the use of the machine.
- People under the age of 18 must not use this product.
- Keep in mind that the operator or user is responsible for accidents or risks to other persons or their property.
- Do not use the tool if you are drunk, tired, under the influence of drugs or ill. Do not use the tool if you are not in an adequate physical condition.
- This tool is intended for outdoor use. Never use it indoors.
- Never allow children use the machine;
- Avoid running it while people, especially children, are around;
- Dress properly! Do not wear loose fitting clothing or jewellery that can be caught in moving parts. Using resistant gloves, non-slip shoes and safety glasses is recommended;
- stop the engine or disconnect it before
  - cleaning or clearing a blockage;
  - Checking, maintaining, or working on the machine;
  - When adjusting the working position of the cutting device.
- Handle fuel with care; it's highly flammable. Never add fuel to a machine with a running engine or when it's hot. Do not inhale fuel fumes as they are toxic;
- Do not attempt to repair the machine unless you are qualified to do so;
- Do not use the machine with a damaged or excessively worn cutting device;
- To reduce the risk of fire, keep the engine and muffler free from debris, leaves or excessive lubricant;

- Always make sure that all handles and guards are installed when operating the machine. Never attempt to use an incomplete machine or a machine equipped with an unauthorized modification
- When transporting or storing the machine, always install the cutting device protection if provided;
- Always be aware of your environment and pay attention to possible dangers that cannot be heard due to the noise of the machine.
- Keep people and animals away from the work area. Children and people who do not know how to use this tool should not touch it and handle it.
- Use the product only under daylight or under good artificial light.
- When using the machine, always wear full protective equipment including a helmet, protective mask, ear protection, gloves, non-slip footwear and protective clothing.
- Wear appropriate clothing. Do not wear loose or unbuttoned shirts. Do not wear jewellery that may come in contact with moving parts. If you have long hair, tie them down and wear an appropriate safety helmet.
- Do not operate the product with damaged guards or shields not in place.
- Keep hands and feet away from the unit at all times, especially when turning the tool off and on.
- Do not use the tool in an area where ventilation is poor. Gas emissions can cause injury.
- Do not work when it rains and in bad weather. Do not use the tool in damp locations.
- Do not use the tool in the presence of flammable liquids or gases.
- Caution: The machine releases gases when it is used. Avoid coming into contact with these gases.
- Keep the work area clear. Before working, inspect the work area and remove any materials or objects that could cause accidents.
- Do not force the tool.
- Keep the tool and drill clean for better and safer performance. Follow the instructions in this manual to lubricate and change the accessories.
- Always inspect the machine before and after operation. If the tool is damaged or faulty, stop using the tool and bring it to an authorized service for inspection and repair.
- Turn off the tool after use, when you leave it unattended, when changing these accessories and before servicing.
- Keep handles dry, clean and free from oil and grease.
- Be concentrated when using the tool. Look at what you do, make sense and do not use the tool when you are tired.
- Place the equipment in a well-lit area on a flat, stable, dry and well-ventilated surface, away from flammable materials.
- Do not allow anyone, especially children, to come within a radius of at least five meters around the work area when all work is in progress.
- Immediately stop the tool in the event of a malfunction of the motor or the ON/OFF button or in case of unusual noise.
- When not in use, the machine must be stored in a dry, locked place out of the reach of children.
- Before using the product and after any shock, please check it for signs of wear or damage. Please carry out repairs if necessary.
- Always switch off the machine:
- Every time you leave the device unattended;
  - Before releasing an obstruction;

- Before checking, cleaning or working on the product;
- After hitting a foreign object;
- Every time the product starts to vibrate abnormally.
- Pay attention to foot and cutting injuries.
- Inspect and regularly service the product. Repairs should be carried out only by an authorized service center or a similar qualified specialist.
- When not in use, store the product out of the reach of children.
- Children should not play with plastic bags, sheets and small parts! Keep them out of the reach of children. There is a danger of suffocation!
- Always carry the tool while holding the handle, never the drill.
- Do not use the product on a slippery surface.
- Do not use the product on steep, slippery slopes.
- If the machine has struck foreign objects, check if the tool is damaged and bring it to repair if necessary.
- Keep away all body parts from the running machine
- Be careful when using the machine in stormy weather. Do not use the machine during lightning, thunderstorms and bad weather in general.
- WARNING: retroactive forces during machine operation
- WARNING: sparks – Risk of fire
- WARNING: inhaling exhaust
- WARNING: the use of damaged machines is inadmissible
- WARNING: the machine produces exhaust fumes, which include hydrocarbons and benzene, when running. Provide sufficient ventilation, not only if used indoors but also when working in trenches, hollows or other confined locations.
- WARNING: Do not work asbestos materials.
- The operator shall have a training for all operations before the use of the machine.
- Secure the machine (add the cover on the drill tip) during transport to prevent the loss of fuel, damage and injury.
- During transport and storage, add the cover on the drill tip.
- Regularly check that the drill stops turning when the engine idles.
- Check the tool after dropping or others impacts to identify any significant defects.
- Keep firm footing and balance during operation.

### 1) Safety instructions for all operations

- a) **Wear ear protectors when impact drilling.** Exposure to noise can cause hearing loss.
- b) **Hold the power tool by insulated gripping surfaces, when performing an operation where the cutting accessory may contact hidden wiring.** Cutting accessory contacting a "live" wire may make exposed metal parts of the power tool "live" and could give the operator an electric shock.

### 2) Safety instructions when using long drill bits

- a) **Never operate at higher speed than the maximum speed rating of the drill bit.** At higher speeds, the bit is likely to bend if allowed to rotate freely without contacting the workpiece, resulting in personal injury.
- b) **Always start drilling at low speed and with the bit tip in contact with the workpiece.** At higher speeds, the bit is likely to bend if allowed to rotate freely without contacting the workpiece, resulting in personal injury.
- c) **Apply pressure only in direct line with the bit and do not apply excessive pressure.** Bits

can bend causing breakage or loss of control, resulting in personal injury.

### Fuel Handling

- Be very careful when handling fuels. They are flammable and the vapors are explosive.
- Use only an approved container.
- Never remove the fuel cap or add fuel while the machine is on. Turn off the unit and allow the engine and exhaust components to cool before refueling.
- Do not smoke.
- Never refuel inside a room
- Never store the tool and the fuel tray indoors where there is a naked flame, such as near a water heater.
- If fuel has spilled, do not attempt to start the machine, but rather move it away from the spill before starting to use it. Clean any spills.
- Replace and tighten the fuel tank cap after refueling.
- Follow the instructions in this manual for filling the tool with fuel.

### During maintenance and storage



- Stop the tool and wait until it stops. Make sure all moving parts have come to a standstill.
- Allow the machine to cool before performing inspection, adjustments, maintenance, servicing and storage.









### Residual risks

**Even if you use this product in accordance with all safety requirements, the potential risks of injuries and damage remain. The following hazards might happen within the structure and design of this product:**

- There are adverse health consequences due to the emission of vibrations if the product is used over long periods of time or not managed properly and maintained in a suitable way.
- There are risks of injuries and property damage caused by the attachments or broken attachments or sudden impact of hidden objects when using the cutting function.
- Risk of damage to persons and property caused by flying objects.
- A prolonged use of this product exposes the operator to vibration and may determine the so-called "white finger" disease. To reduce the risk, please wear gloves and keep your hands warm. It is recommended to limit the duration of operation.
- If any of the symptoms of the "white finger" syndrome appear, consult a doctor immediately. Symptoms of the "white finger" include: numbness, loss of sensitivity, tickling, tingling, pain, loss of strength, colour changes or skin condition. These symptoms usually appear on fingers, hands or wrists. The risk is higher at low temperatures.
- Risk of hearing loss if the machine is used for long periods of time without hearing protection. It is recommended to limit the duration of operation.
- There is a risk of blockage during use; in case of blockage, stop immediately the machine; inspect the machine and clear the blockage in a secure way.

### Symbols

	Warning symbol.
	Read the instruction manual.

	Wear protective equipment: protective helmet, safety glasses, noise protection helmet.
	Wear protective gloves.
	Wear protective foot wear.
	CAUTION: Hot surface.
	Don't smoke.
	Guarantee sound power level.
	Wear a mask of protection.
	Beware of thrown objects.

## 3. YOUR PRODUCT

### 3.1 DESCRIPTION



1. Fuel cap/tank
2. ON/OFF Switch
3. Throttle
4. Handle
5. Gear box
6. Auger/Drill
7. Spark plug
8. Air filter/Carburetor
9. Choke lever
10. Recoil starter handle

## 2.2 TECHNICAL DATA

Engine displacement	52cm <sup>3</sup>
Maximum engine power:	1.45kW
Maximum speed of the motor	8500/min
Engaging speed	3800/min
Recommended engine idling speed	3000/min
Gear ratio	30:1
Maximum diameter of drill	300 mm
Maximum length of drill	1000 mm
Engine idling speed range	3100 ± 500 mm <sup>-1</sup>
Fuel tank volume	1.2L
Drilling specific diameter	100mm/150mm/200mm
Drilling speed at the maximum speed of themachine	240/min
Fuel consumption at maximum engine power	≥700g/h
Ratio of fuel to oil	40:1
Guaranteed sound power	116dB(A)
Sound pressure	Idling speed L <sub>PA</sub> =68.4dB(A) K= 3dB(A) In operation L <sub>PA</sub> =93.8dB(A) K= 3dB(A)
Sound power	Idling speed L <sub>WA</sub> =88.4 dB(A) K= 3dB(A) In operation L <sub>WA</sub> =113.8dB(A) K= 3dB(A)
Vibration	Idling speed Main handle 5.948ms <sup>2</sup> K=1.5m/s <sup>2</sup> Auxiliary handle 6.812ms <sup>2</sup> K=1.5m/s <sup>2</sup> In operation Main handle 20.520ms <sup>2</sup> K=1.5m/s <sup>2</sup> Auxiliary handle 20.984ms <sup>2</sup> K=1.5m/s <sup>2</sup>
Weight	10 kg



## 4. FILLING THE FUEL TANK

### **WARNING: When filling the tank:**

- The drill should always be stopped and cooled.
- Never smoke during refueling. It must not have flames or sparks near the fuel.
- Do not attempt to refuel when the engine is hot.
- If fuel has been spilled, immediately stop refueling and do not start the engine. Clean up the spill and fill the machine in another location.
- Never fill the fuel tank to the flange; there is a risk of overflow.
- Do not refuel in a closed and unventilated area.

The fuel used for this tool is a mixture of unleaded gasoline and registered engine lubricant. When mixing gasoline with oil, use only gasoline that does not contain ethanol or methanol. Unleaded gasoline is a quality gasoline type. This will help to avoid damaging the fuel lines of the engine and other engine parts. The recommended mixing ratio is 40:1 (make sure the mixing ratio is correct before filling the product).

### **a) Mixing**

- Prepare the mixture in a clean and empty container.
- Pour the oil into the container.
- Pour the fuel into the tank. Stir the mixture long enough (more than one minute)

### **b) Filling the fuel tank**

- Unscrew the fuel tank cap and remove it.
- Fill the tank slowly with the mixture. Do not exceed the maximum capacity (fill to 80% of its capacity preferably).
- Replace the cap on the fuel tank and tighten it.
- Wipe any spillage around the unit if necessary

**Note: To avoid damage and accidents, DO NOT USE OTHER MIXTURES AND OTHER TYPES OF OIL / PETROL**

### **c) Storage of fuel**

- The fuel must be kept in a clean and safe container and always closed.
- If you are not using the product for a long time, remove the fuel mixture and add it to a container.
- Do not leave the fuel for a long time in the product. The fuel may clog the carburetor and the engine will not operate properly.

### **d) Disposal of fuel**

- When the fuel is no longer used or worn, please dispose of it in an authorized location. Check local laws regarding disposal of fuels.

## 5. ASSEMBLY & OPERATION

### **5.1 Attaching the auger/drill bit. (Fig.1)**

- Remove the securing pin and then the screw from the bit.
- Push the auger/drill bit onto the shaft.
- Align the hole of the auger/drill with the hole of the shaft. Place the screw into the hole and then push the securing pin in the hole of the screw.

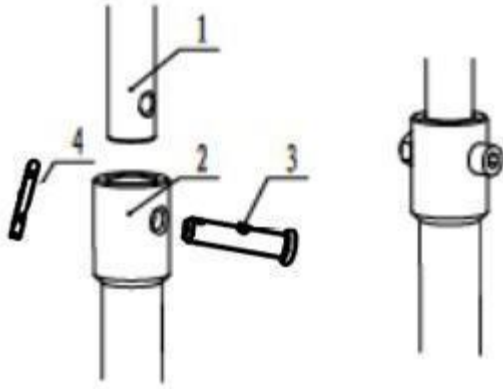

(Fig. 1)

### 5.2 Starting the engine. (Fig.3-4)

- Fill with fuel as described in section 3.
- Put the I/O switch (ON/OFF) to the I position (ON).
- Push the choke lever to the close position 
- Push the primer bulb until fuel flows into the clear tube.

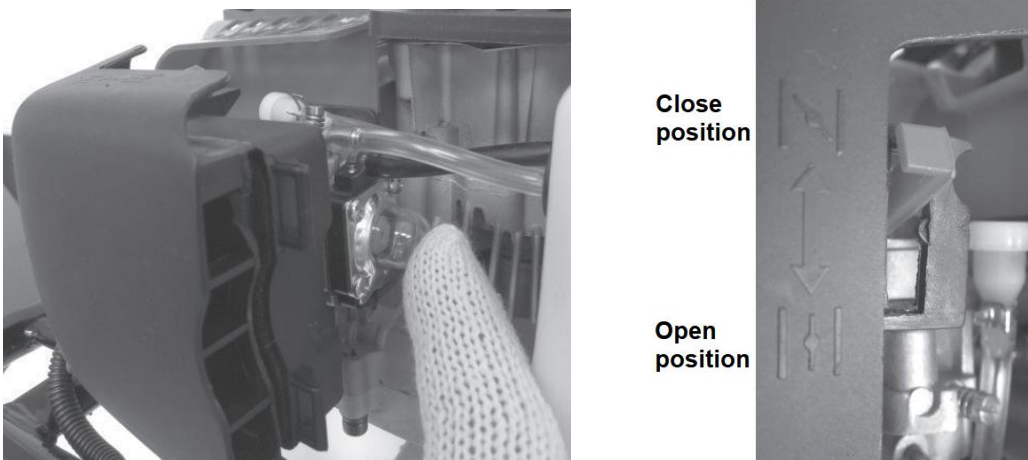
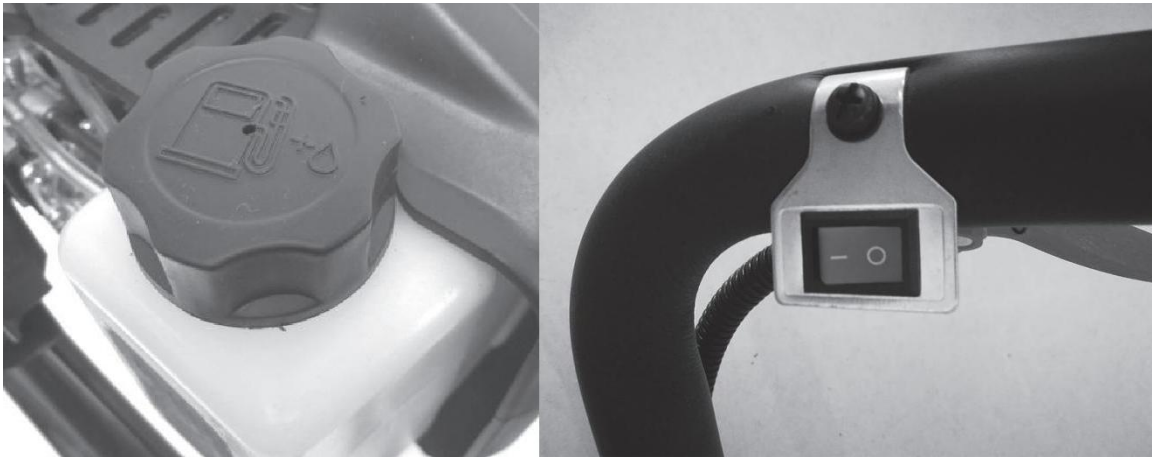

### NOTE:

- When restarting immediately after stopping the engine leave the choke in the open position (6).
- The primer pump operation is not necessary when restarting the engine immediately after stopping.

- Whilst supporting the auger with your left waist and left hand as shown, pull the starter recoil handle gently until compression is felt then firmly. (Fig.6)



(Fig. 6)

**Warning:** Keep everything clear of the drill because it will start rotating upon starting of engine.

- When the engine has started, gradually open the choke lever  .
- Allow the engine to warm up for a half minutes before starting operation.

**Note:**

- When re-starting immediately after stopping the engine, keep the choke open.
- If the engine won't start after repeated attempts, it may be overfed with fuel. Remove and dry the spark plug, and try to start again with the choke open.

**5.3 Stopping the engine. (Fig.7)**

- Release the throttle lever to allow the engine to idle for a few minutes
- Put the I/O switch (1) to the "0" position (OFF).

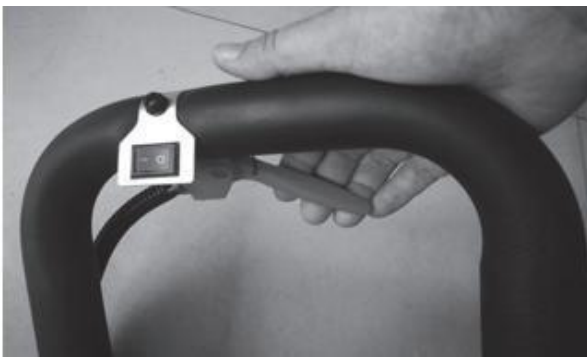

**5.4 Drilling. (Fig.8)**

- Keep a firm grip of the auger at all times, keeping wide stance and by holding the handle with both hands.
- A reacting motion may occur on the auger when spinning drill has hit on stones or tree roots under the ground. Always hold the auger firmly to control such motion.
- Start drilling with half-throttle, and gradually increase the engine speed so that the drill may get into the ground smoothly.
- When the drill has been caught in the ground and cannot be pulled out, stop the operation.



(Fig.8)

### 5.5 Adjusting the carburetor.

- The carburetor on your unit has been factory adjusted, but may require fine tuning due to change in operating conditions. Before adjusting the carburetor, make sure that the air/fuel filters are clean the machine has fresh, properly mixed fuel.
- Stop the engine and screw in both H (4) and L (7) needles until they stop. Never force. Then set them back the initial number of turns as shown below.
- Start engine and allow it to warm up at half- throttle.
- Turn L (7) needle slowly clockwise to find a position where idling speed is maximum, then set the needle back a quarter ( $\frac{1}{4}$ ) turn counterclockwise.
- Turn idle adjusting screw (1) counterclockwise so that the drill does not turn. If idling speed is too slow, turn the screw clockwise.
- Make a test run and adjust the H (4) needle for best drilling power, not for maximum speed.

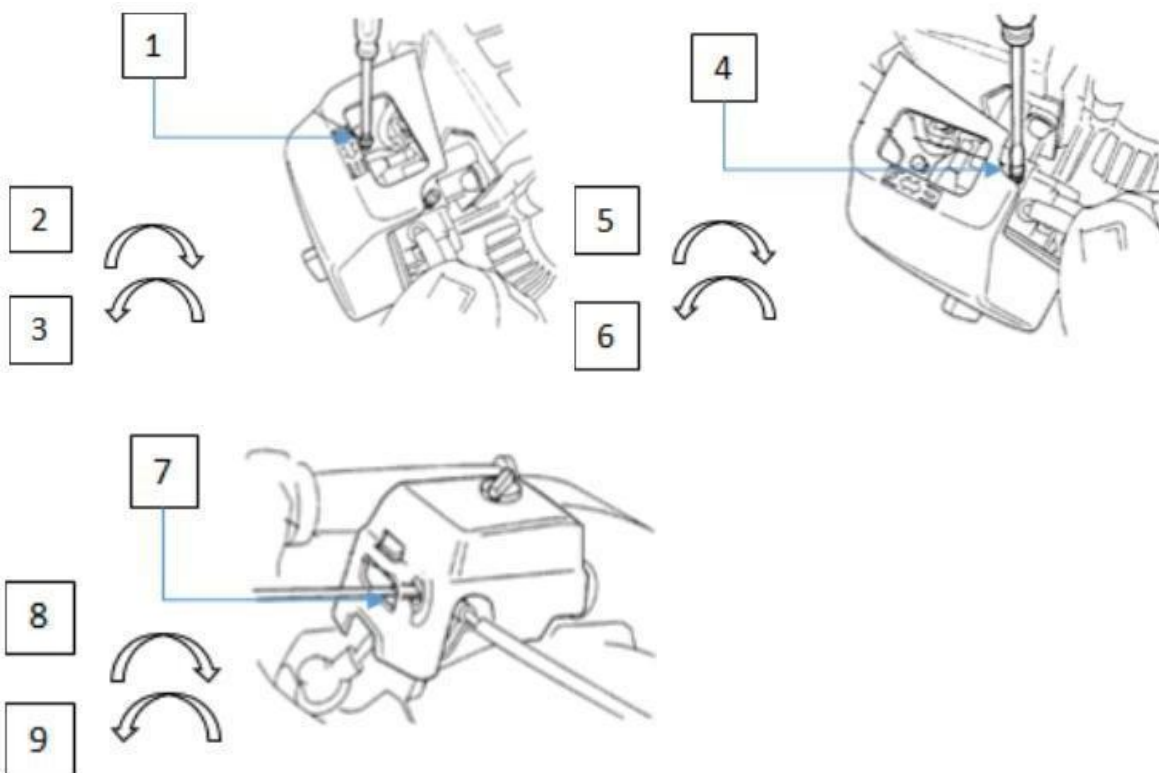

1 – Idle adjusting screw

4 – H-Needle

7 - L-Needle

2 – RPM up

5 – Fuel decrease

8 – Fuel decrease

3 – RPM down

6 – Fuel increase

9 – Fuel increase

## 6. MAINTENANCE AND STORAGE

### Warning:

Before cleaning, inspecting or repairing the auger, make sure that the engine has stopped and cooled down. Disconnect the spark plug terminal to avoid accidental engine starts. Irregular and improper maintenance/cleaning will deteriorate the tool and bring damages and accidents.

The maintenance shall be performed by a qualified service agent in case that the user has no experience about these tasks.

Keep the machine in good working condition.

If parts need to be replaced, contact your service agent for information. Do not make any replacement by yourself without knowing the spare parts to be used and you do have the knowledge for this.

Do not use spare parts which are not recommended. The fact to use incorrect spare parts can damage the tool and bring accidents.

### 6.1. Daily inspection

6.1.1. Check all nuts and screws are securely tightened and no parts are missing.

6.1.1.1. Before using machine replace any missing fixing nuts and screws.

6.1.2. Check for leakage of fuel.

6.1.2.1. Clean up all fuel spills immediately, repair any leaks before starting the engine.

### 6.2. Air filter.

6.2.1. Check the air filter every 50 hours of use.

6.2.1.1. To remove filter undo cover (1) to reveal filter (2).

6.2.1.2. Clean the element in warm soapy water as necessary. Dry completely before installing.

6.2.1.2.1. You must clean more frequently if used under very dusty conditions.

6.2.1.3. Replace damaged filter.

6.2.1.4. DO NOT run machine without filter fitted.

### 6.3 Spark plug. (Fig.9-10-11)

6.3.1. Check the spark plug every 50 hours of use and clean the gap with a wire brush.

6.3.2. The gap should be set to 0.6 – 0.7mm. When replacing with a new plug, use a Champion RCJ-6Y or NGKBPMR7A.

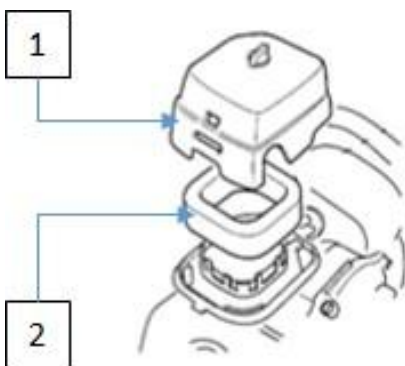

Fig.9

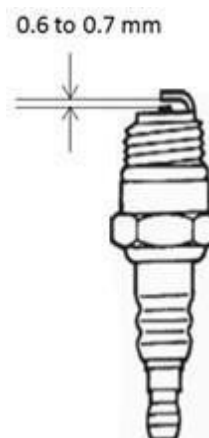

Fig.10

**Warning:**

**The spark plug MUST be fully tightened otherwise the engine will overheat causing damage.**

**Always complete the following steps with the engine off and cooled.**

6.3.3. Undo retaining screw (1) and lift spark plug cover (2) clear.

6.3.4. Disconnect the spark plug cap (3) carefully. Do not pull on the HT lead instead pull on the spark plug cap (3).

6.3.5. Using the supplied spark plug wrench unscrew the spark plug.

6.3.6. Insert the spark plug (4) in an anti-clockwise direction.

6.3.7. Check the spark plug (4) visually for damage and electrode consumption, remove the carbon deposits.

6.3.8. Check the gap with a feeler gauge and turn the electrode on the right distance of 0.6 to 0.7mm.

6.3.9. To re-insert spark plug tighten up gently by hand to avoid cross threading, once done tighten it using a box spanner ¼ turn more. Make sure the spark plug is tightened correctly otherwise damage can occur.

6.3.10. Refit the spark plug cap onto the spark plug.

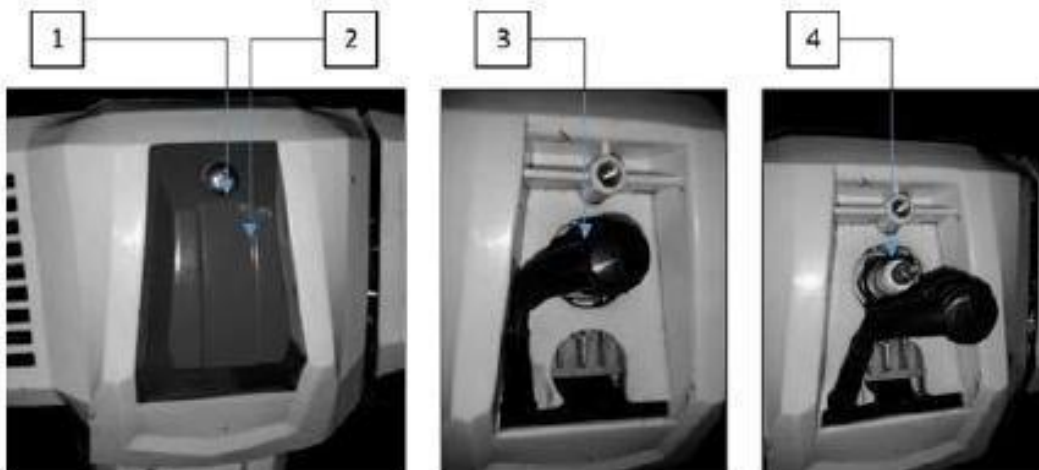

Fig.11

**NOTE:** The use of any spark plug other than the one designated may result in the engine failing to run correctly becoming overheated and damaged.

**6.4. Fuel filter. (Fig.12)**

A clogged fuel filter can cause lack of power and poor pickup. Check the fuel filter every 25 use hours

6.4.1. Remove the fuel cap (1) and empty the remaining fuel into an approved container.

6.4.2. With a small wire hook, pull the fuel line and filter (2) out of tank.

6.4.3 Disconnect the filter assembly.

6.4.4. If necessary, replace with new filter or clean by blowing air inside out after spraying a carburetor cleaning solvent.

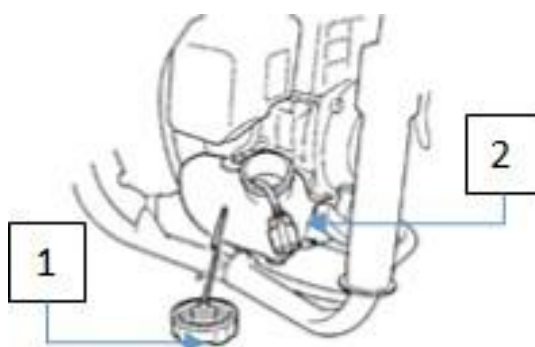

Fig.12



## 6.5. Gear box. (Fig.13)

6.5.1. Check oil level of the gear box every 50 hours of use and change with new oil as necessary(SAE 80 - 90).

6.5.2. To remove old oil undo drain bolt (2) and pour used oil into an approved container and dispose of at your local recycling center. Remember to refit drain bolt (2).

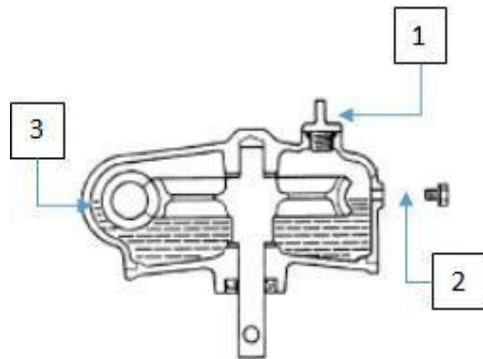

Fig.13

6.5.3. To fill with or top up oil undo the oil filler cap (1)

6.5.4. Recommended change interval.

6.5.4.1. 1st change after 50 hours of use.

6.5.4.2. 2nd and on every 100 hours of use.

## 7. TROUBLESHOOTING

**Note:** If troubleshooting does not solve the problem, contact your dealer or the manufacturer directly. Use only original parts approved by the manufacturer, otherwise a hazard risk arises.

### 7.1 Difficulties in starting.

Situation		Cause	Solution
<b>No spark</b>	Spark plug	Carbon deposit between electrodes of the spark plug	Clean the spark plug. Adjust the gap to 0.6 ~ 0.7mm, Replace the spark plug
	Other	Ignition coil defective	Replace the Ignition coil
<b>Weakspark</b>	Compression	Too much fuel in the combustion chamber, poor fuel or water in tank	Remove spark plug and dry, replace fuel.
	Carburetor pumps no fuel more.	Blocked fuel line	Clean the carburetor and clean the lines
<b>Normal fuel supply but weak compression</b>		Worn piston rings, spark plug not tightened, the cylinder head is not tightly wrong valve clearance or ignition	Replace or adjust
<b>Problem with fuel supply and spark</b>		Poor contact between spark plug cap and spark plug	Check or exchange

## 7.2 Difficulties during operation.

<b>Situation</b>	<b>Cause</b>	<b>Solution</b>
<b>Motor does not come up to speed</b>	Choke is in "cold start" position, exhaust system does not clog air supply, worn Movable elements, spark weak Sooty cylinder head	Open choke, exhaust system ignition coil exchange check or replace, flywheel Adjust spark plug
<b>Power run out</b>	Congested fuel line. Incorrect spark plug gap	Clear or replace fuel lines Adjust spark plug gap set gap
<b>Engine sounds</b>	Incorrect choke position, damaged crankshaft	Adjust choke position Check/Replace crankshaft
<b>Leaking carburetor</b>	Failure of the non-return valve on the tank lid. Worn carburetor gasket	Replace the fuel cap Replace the carburetor or seal

## 8. STORAGE & TRANSPORTATION

**WARNING:** If you do not follow these steps, deposit may arise in the carburetor. This will cause starting difficulties and may cause permanent damage

8.1. Perform all the general maintenance that the maintenance section of your 'User Manual' is recommended.

8.2. Clean the outside of the machine, drive axle, shield and nylon cutting head.

8.3. Remove all fuel from the fuel tank.

8.4. After all the fuel is drained, start the engine.

8.5. Allow the engine to run in idle until engine stops alone. This allows the fuel to be removed from the carburetor.

8.6. Allow engine to cool down (about 5 minutes).

8.7. Use a spark plug wrench, remove the spark plug.

8.8. Pour 1 teaspoon of clean 2-cycle oil into the combustion chamber. Slowly pull the starter rope several times to coat internal components. Replace the spark plug.

8.9. Store the machine in a cool, dry place away from any source of ignition such as an oil burner, water heater etc.

8.10. Transporting the machine.

8.10.1. When transporting the machine make sure that no fuel is leaking

8.10.2. DO NOT allow the tool come into contact with persons, animals and property.



## 9. DECLARATION OF CONFORMITY



BUILDER SAS

32 rue Aristide Bergès - Z.I. du Casque - 31270 Cugnaux - France

Declares that the machinery designated below:

PETROL EARTH AUGER

RACTT50-4

Serial number: 20221200741-20221202615

Complies with the provisions of the Directive “machinery” 2006/42/EC and national laws transposing it:

Also complies with the provisions of the following European directives: EMC Directive 2014/30/EU  
ROHS Directive (EU)2015/863 amending 2011/65/EU  
Emission directive (EU) 2016/1628 &2018/989/EU

Directive on environmental noise emissions from equipment intended for use outside buildings 2000/14 /EC and 2005/88/EC

Also complies with European standards, with national standards and the following technical provisions

PPP 58068A :2013  
AfPS GS 2019:01 PAK  
EK9-BE-98(v2):2020  
EN ISO 14982:2009

Cugnaux, 31/10/2022

Philippe MARIE / CEO

# 10. WARRANTY



## WARRANTY

The manufacturer guarantees the product against defects in material and workmanship for a period of 2 years from the date of the original purchase. The warranty only applies if the product is for household use. The warranty does not cover breakdowns due to normal wear and tear.

The manufacturer agrees to replace parts identified as defective by the designated distributor. The manufacturer does not accept responsibility for the replacement of the machine, in whole or in part, and/or ensuing damage.

### The warranty does not cover breakdowns due to:

- insufficient maintenance.
- abnormal assembly, adjustment or operations of the product.
- parts subject to normal wear and tear.

### The warranty does not extend to:

- shipping and packaging costs.
- using the tool for a purpose other than that for which it was designed.
- the use and maintenance of the machine done in a manner not described in the user manual.

Due to our policy of continuous product improvement, we reserve the right to alter or change specifications without notice. Consequently, the product may be different from the information contained therein, but a modification will be undertaken without notice if it is recognized as an improvement of the preceding characteristic.

### READ THE MANUAL CAREFULLY BEFORE USING THE MACHINE.

When ordering spare parts, please indicate the part number or code, you can find this in the spare parts list in this manual. Keep the purchase receipt; without it, the warranty is invalid. To help you with your product, we invite you to contact us by phone or via our website:

- **+33 (0)9.70.75.30.30**
- **<https://services.swap-europe.com/contact>**

You must create a "ticket" via the web platform.

- Register or create your account.
- Indicate the reference of the tool.
- Choose the subject of your request.
- Describe your problem.
- Attach these files: invoice or sales receipt, photo of the identification plate (serial number), photo of the part you need (for example: pins on the transformer plug which are broken).



# 11. PRODUCT FAILURE

## WHAT TO DO IF MY MACHINE BREAKS DOWN?

### **If you bought your product in a store:**

- a) Empty the fuel tank if your product has one.
- b) Make sure that your machine is complete with all accessories supplied, and clean! If this is not the case, the repairer will refuse the machine.

Go to the store with the complete machine and with the receipt or invoice.

### **If you bought your product on a website:**

- a) Empty the fuel tank if your product has one.
- b) Make sure that your machine is complete with all accessories supplied, and clean! If this is not the case, the repairer will refuse the machine.
- c) Create a SWAP-Europe service ticket on the site: <https://services.swap-europe.com> When making the request on SWAP-Europe, you must attach the invoice and the photo of the nameplate (serial number).
- d) Contact the repair station to make sure it is available before dropping off the machine.

Go to the repair station with the complete machine packed, accompanied by the purchase invoice and the station support sheet downloadable after the service request is completed on the SWAP-Europe site

For machines with engine failure from manufacturers BRIGGS & STRATTON, HONDA and RATO, please refer to the following instructions.

Repairs will be done by approved engine manufacturers of these manufacturers, see their site:

- <http://www.briggsandstratton.com/eu/fr>
- <http://www.honda-engines-eu.com/fr/service-network-page;jsessionid=5EE8456CF39CD572AA2AEEDFD290CDAE>
- <https://www.rato-europe.com/it/service-network>

**Please keep your original packaging to allow for after-sales service returns or pack your machine with a similar cardboard box of the same dimensions.**

**For any question concerning our after-sales service you can make a request on our website <https://services.swap-europe.com>**

**Our hotline remains available at +33 (9) 70 75 30 30.**



# 12. WARRANTY EXCLUSIONS

## THE WARRANTY DOES NOT COVER:

- Start-up and setting up of the product.
- Damage resulting from normal wear and tear of the product.
- Damage resulting from improper use of the product.
- Damage resulting from assembly or start-up not in accordance with the user manual.
- Breakdowns related to carburetion beyond 90 days and fouling of carburetors.
- Periodic and standard maintenance events.
- Actions of modification and dismantling that directly void the warranty.
- Products whose original authentication marking (brand, serial number) has been degraded, altered or withdrawn.
- Replacement of consumables.
- The use of non-original parts.
- Breakage of parts following impacts or projections.
- Accessories breakdowns.
- Defects and their consequences linked to any external cause.
- Loss of components and loss due to insufficient screwing.
- Cutting components and any damage related to the loosening of parts.
- Overload or overheating.
- Poor power supply quality: faulty voltage, voltage error, etc.
- Damages resulting from the deprivation of enjoyment of the product during the time necessary for repairs and more generally the costs related to the immobilization of the product.
- The costs of a second opinion established by a third party following an estimate by a SWAP-Europe repair station
- The use of a product which would show a defect or a breakage which was not the subject of an immediate report and/or repair with the services of SWAP-Europe.
- Deterioration linked to transport and storage\*.
- Launchers beyond 90 days.
- Oil, petrol, grease.
- Damages related to the use of non-compliant fuels or lubricants.

\* In accordance with transport legislation, damage related to transport must be declared to carriers within 48 hours maximum after observation by registered letter with acknowledgement of receipt.

This document is a supplement to your notice, a non-exhaustive list.

**Attention:** all orders must be checked in the presence of the delivery person. In case of refusal by the delivery person, it you must simply refuse the delivery and notify your refusal.

**Reminder:** the reserves do not exclude the notification by registered letter with acknowledgement within 72 hours.

**Information:** Thermal devices must be wintered each season (service available on the SWAP-Europe site). Batteries must be charged before being stored.



BUILDER SAS  
32 rue Aristide Bergès - Z.I. du Casque - 31270 Cugnaux - France  
MADE IN PRC 2022